

Analog Devices Welcomes Hittite Microwave Corporation

NO CONTENT ON THE ATTACHED DOCUMENT HAS CHANGED



THIS PAGE INTENTIONALLY LEFT BLANK

ULTRA LOW PHASE NOISE AMPLIFIER MODULE, 1.5 - 5 GHz



Features

- Ultra Low Phase Noise: -163 dBc/Hz @ 1 kHz
- Gain: 14 dB
- Output Power: +22 dBm
- Single Supply Voltage: +7V @ 170mA
- Hermetically Sealed Module
- 55 °C to +85 °C Operating Temperature

Typical Applications

The HMC-C077 is ideal for:

- Microwave Radio
- Military & Space
- Test Instrumentation
- VSAT

Functional Diagram

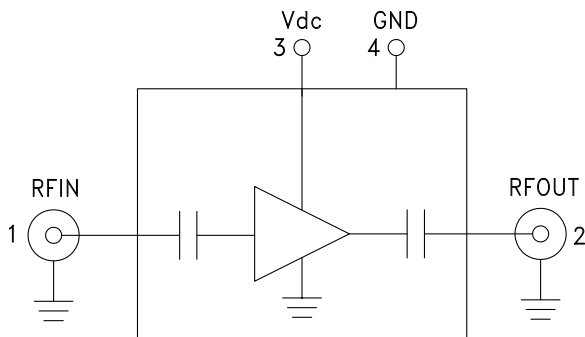

General Description

The HMC-C077 is a GaAs HBT Ultra Low Noise Amplifier in a miniature, hermetic module designed to operate between 1.5 and 5 GHz. This high dynamic range amplifier module provides 14 dB of gain, 4.5 dB noise figure and up to +22 dBm of output power with a single supply of +7V. The ultra low phase noise contribution of -163 dBc/Hz at 1 kHz offset, enables superior modulation accuracy within transceiver architectures. The wideband distributed amplifier I/O's are internally matched to 50 Ohms and DC blocked for robust performance. The module features removable SMA connectors which can be detached to allow direct connection of the I/O pins to a microstrip or coplanar circuit.

Electrical Specifications, $T_A = +25\text{ }^\circ\text{C}$, $V_{dc} = +7V$

Parameter	Min.	Typ.	Max.	Min.	Typ.	Max.	Units
Frequency Range	1.5 - 5			2 - 4			GHz
Gain	9	14		11	14		dB
Gain Flatness		± 3.5			± 1.5		dB
Gain Variation Over Temperature		0.01			0.01		dB/ °C
Noise Figure		4.5			4		dB
Input Return Loss		19			19		dB
Output Return Loss		15			15		dB
Output Power for 1 dB Compression (P1dB)	15	17		15	17		dBm
Output Power			22			22	dBm
Output Third Order Intercept (IP3)		27			27		dBm
Phase Noise @ 1 kHz, Pout = +22 dBm		-163			-163		dBc/Hz
Phase Noise @ 10 kHz, Pout = +22 dBm		-171			-171		dBc/Hz
Phase Noise @ 100 kHz, Pout = +22 dBm		-175			-175		dBc/Hz
Supply Current (all conditions)		170	240		170	240	mA

**ULTRA LOW PHASE NOISE
AMPLIFIER MODULE, 1.5 - 5 GHz**



Gain & Return Loss

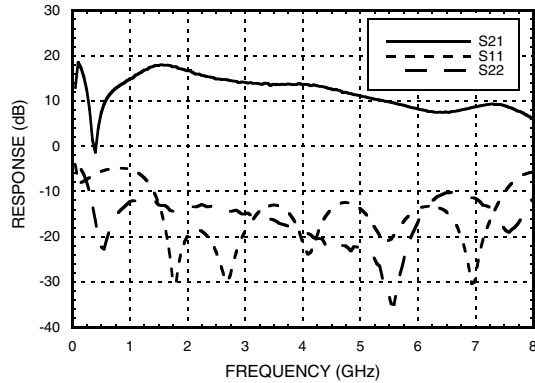

Gain vs. Temperature

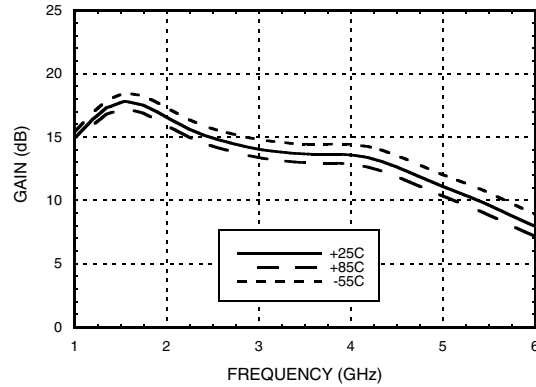

Input Return Loss vs. Temperature

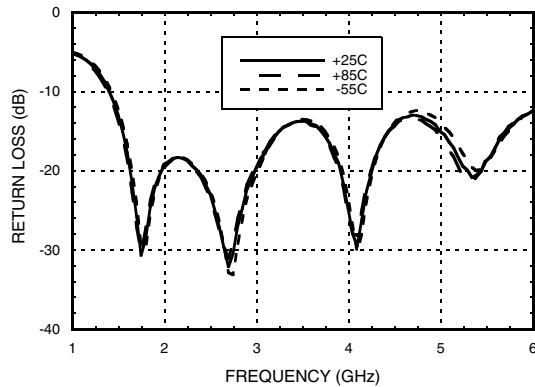

Output Return Loss vs. Temperature

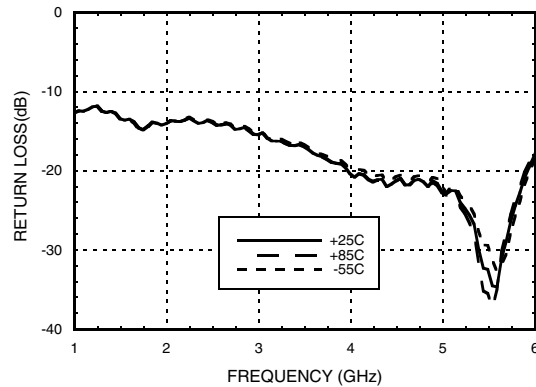

Noise Figure vs. Temperature

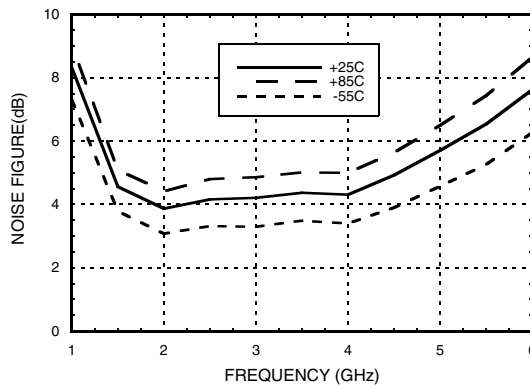

**ULTRA LOW PHASE NOISE
AMPLIFIER MODULE, 1.5 - 5 GHz**



Output P1dB vs. Temperature

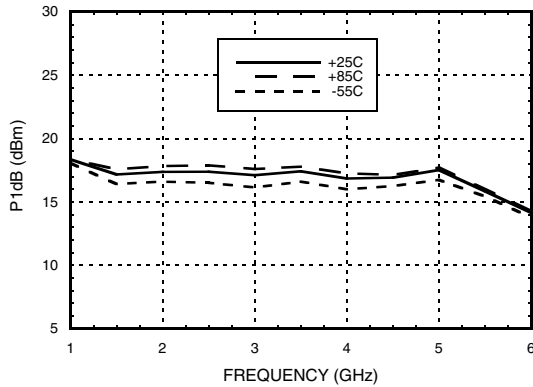

Output IP3 vs. Temperature

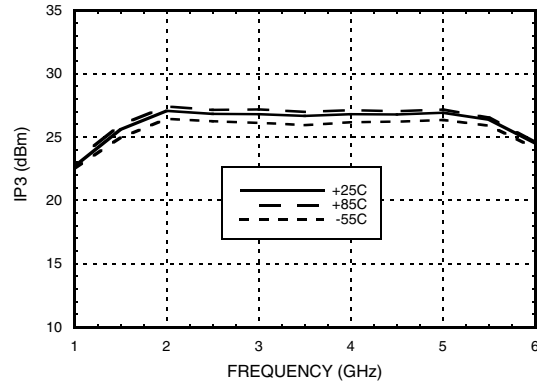

Phase Noise at Pout = +10 dBm @ 3 GHz

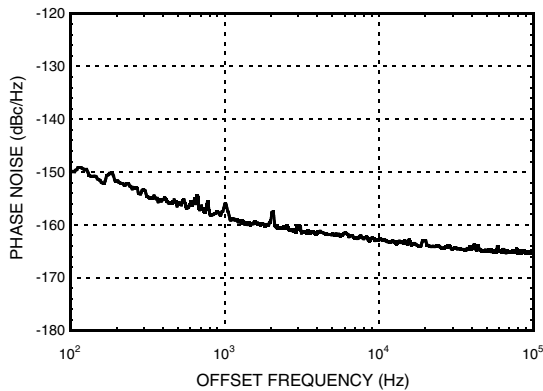

Phase Noise at Pout = P1dB @ 3 GHz

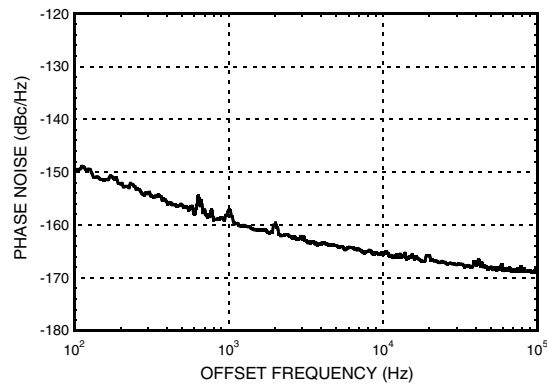

Pout & Icc vs. Temperature

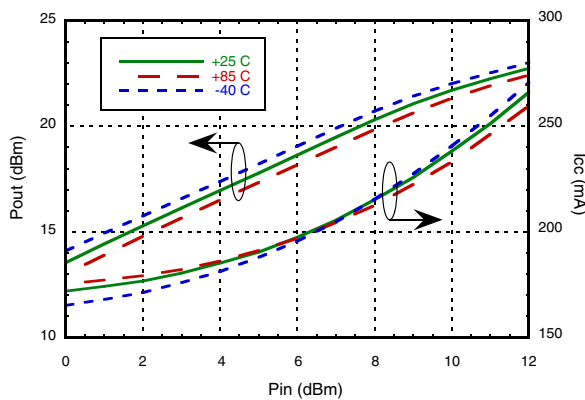

Phase Noise at Pout = +22 dBm @ 3 GHz

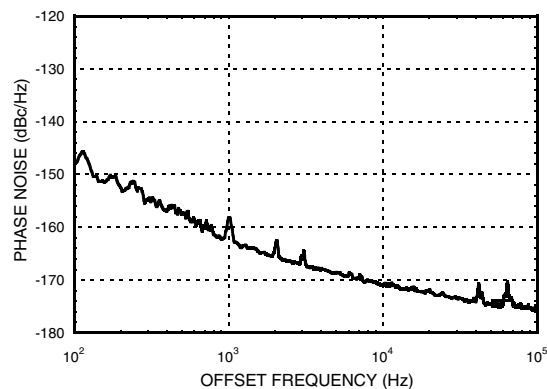



ULTRA LOW PHASE NOISE AMPLIFIER MODULE, 1.5 - 5 GHz



Absolute Maximum Ratings

Bias Supply Voltage (Vdc)	+9V
RF Output Power (RFOUT)	+22 dBm
RF Input Power (RFIN)	+15 dBm
Continuous P _{diss} (T = 85 °C)	1.6W
Storage Temperature	-65 to +150 °C
Operating Temperature	-55 to +85 °C
ESD Sensitivity (HBM)	Class 1A

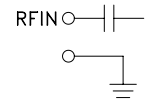
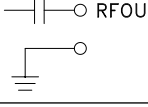
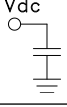

ELECTROSTATIC SENSITIVE DEVICE
OBSERVE HANDLING PRECAUTIONS

Pin Descriptions

Pin Number	Function	Description	Interface Schematic
1	RFIN & RF Ground	RF input connector, coaxial female, field replaceable. This pin is AC coupled and matched to 50 Ohms.	
2	RFOUT & RF Ground	RF output connector, coaxial female, field replaceable. This pin is AC coupled and matched to 50 Ohms.	
3	Vdc	Power supply voltage for the amplifier. (+7V to +9V)	
4	GND	Power supply ground.	



ULTRA LOW PHASE NOISE AMPLIFIER MODULE, 1.5 - 5 GHz

Outline Drawing

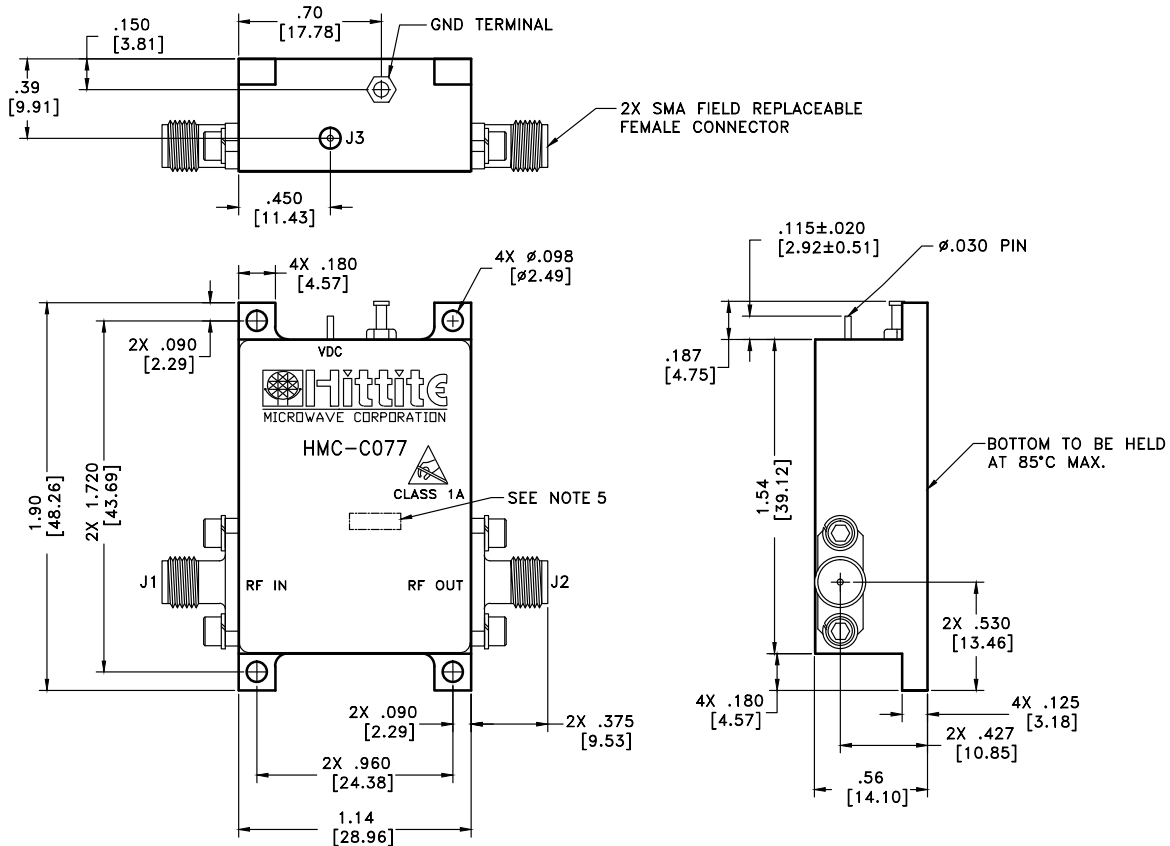

Package Information

Package Type	C-16
Package Weight	107 gms [1]

[1] ±1 gms Tolerance

NOTES:

1. PACKAGE, LEADS, COVER MATERIAL: KOVAR™
2. FINISH: GOLD PLATE OVER NICKEL PLATE.
3. ALL DIMENSIONS ARE IN INCHES [MILLIMETERS].
4. TOLERANCES:
 - 4.1 .XX = ±.02
 - 4.2 .XXX = ±.010
5. MARK LOT NUMBER ON 0.080 X 0.250 LABEL WHERE SHOWN, WITH 0.030" MIN TEXT HEIGHT.

**ULTRA LOW PHASE NOISE
AMPLIFIER MODULE, 1.5 - 5 GHz**



Notes: